

1500 Optional

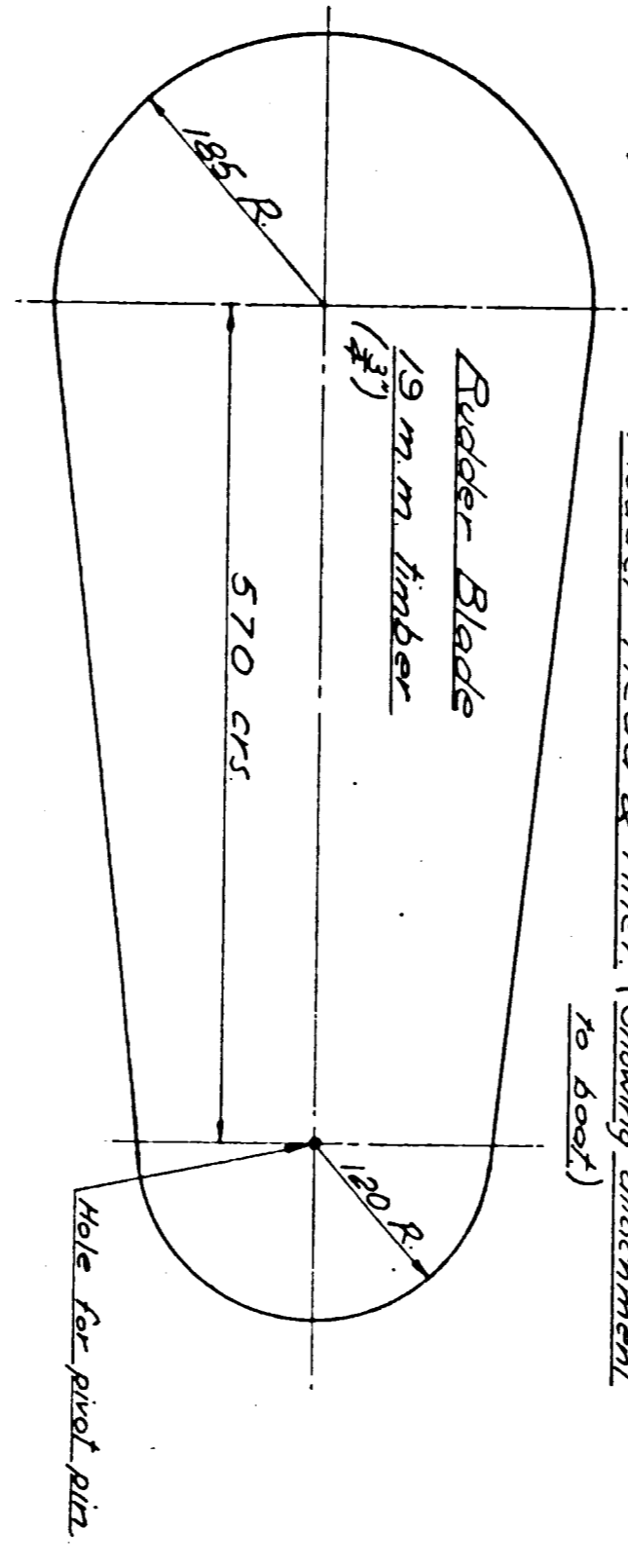

Measurements on rubber and C/B detail are in millimeters

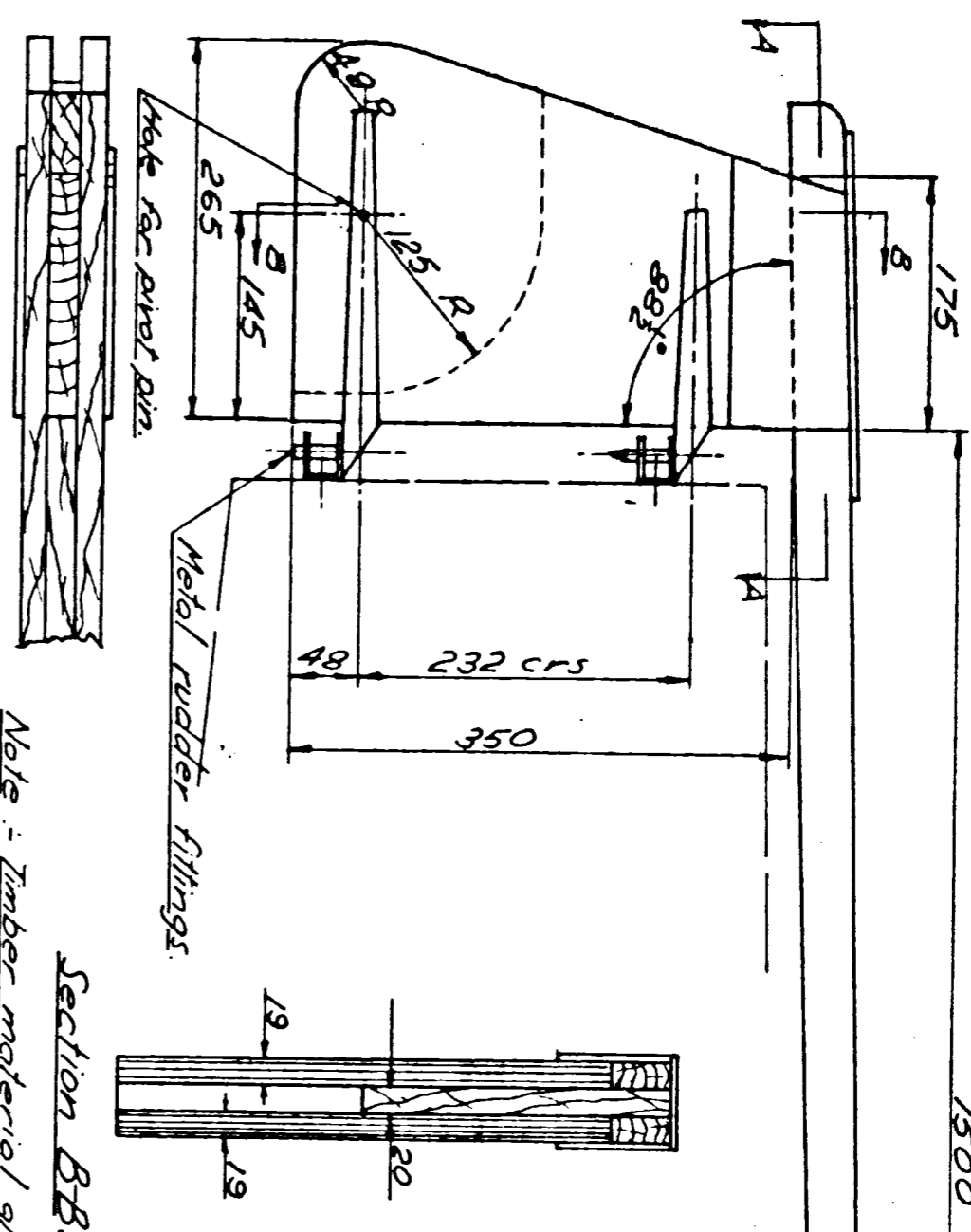
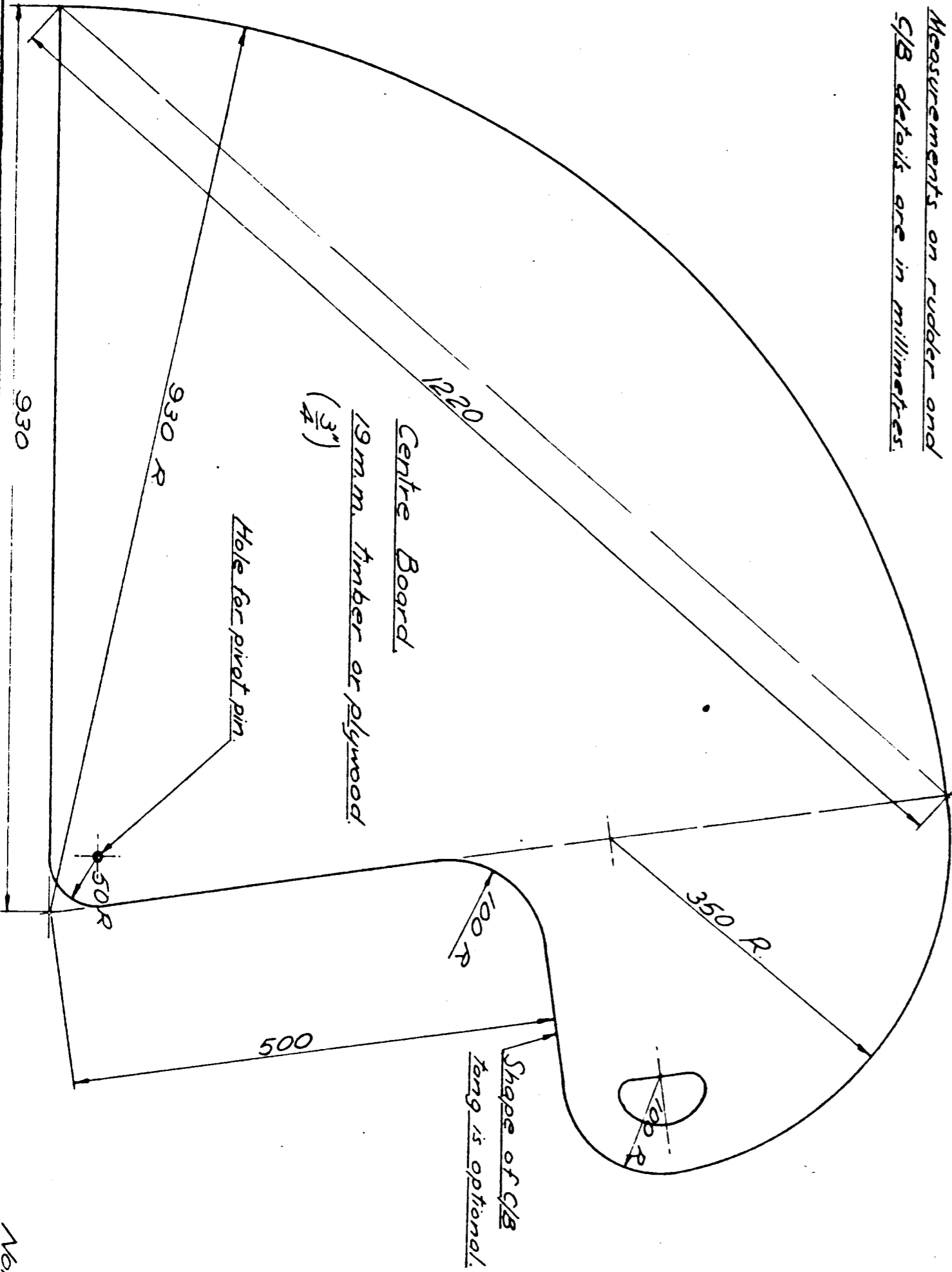

Tiller extension optional length & material

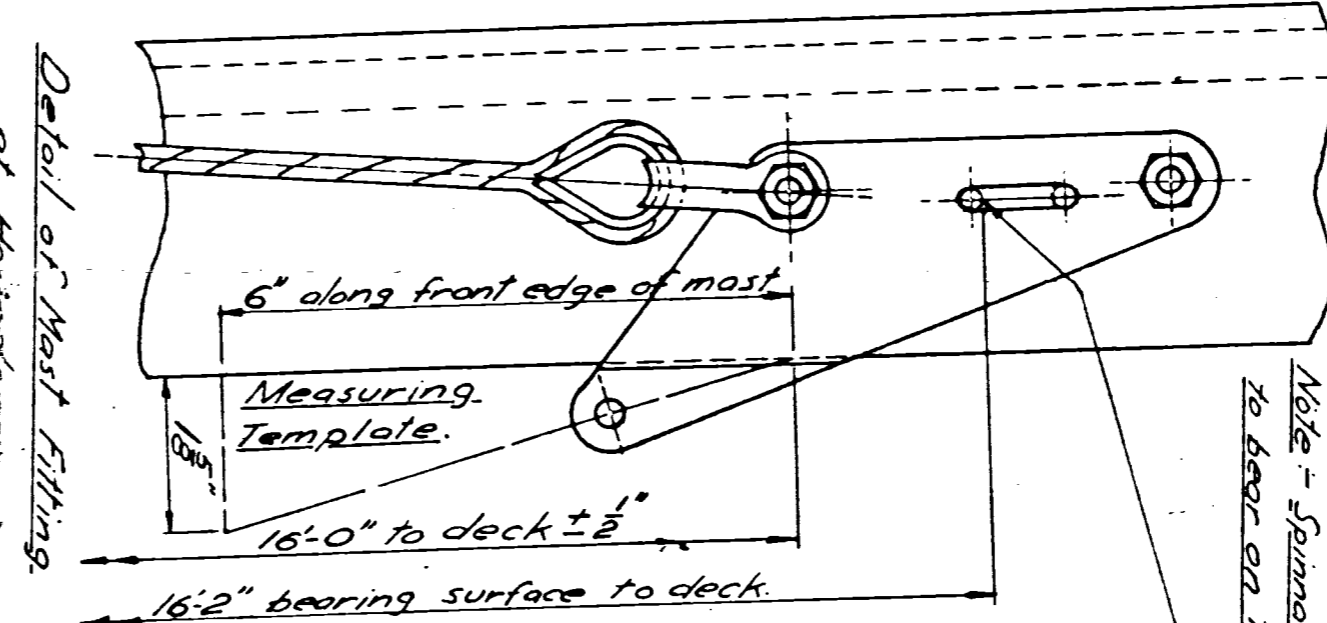
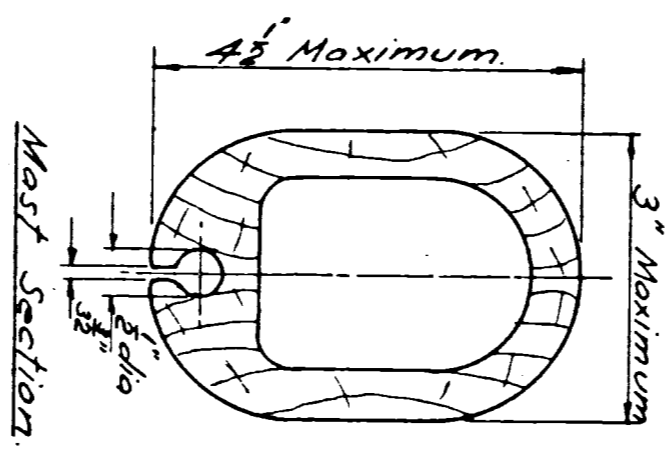

Note - Spinnaker hollard to bear on this surface

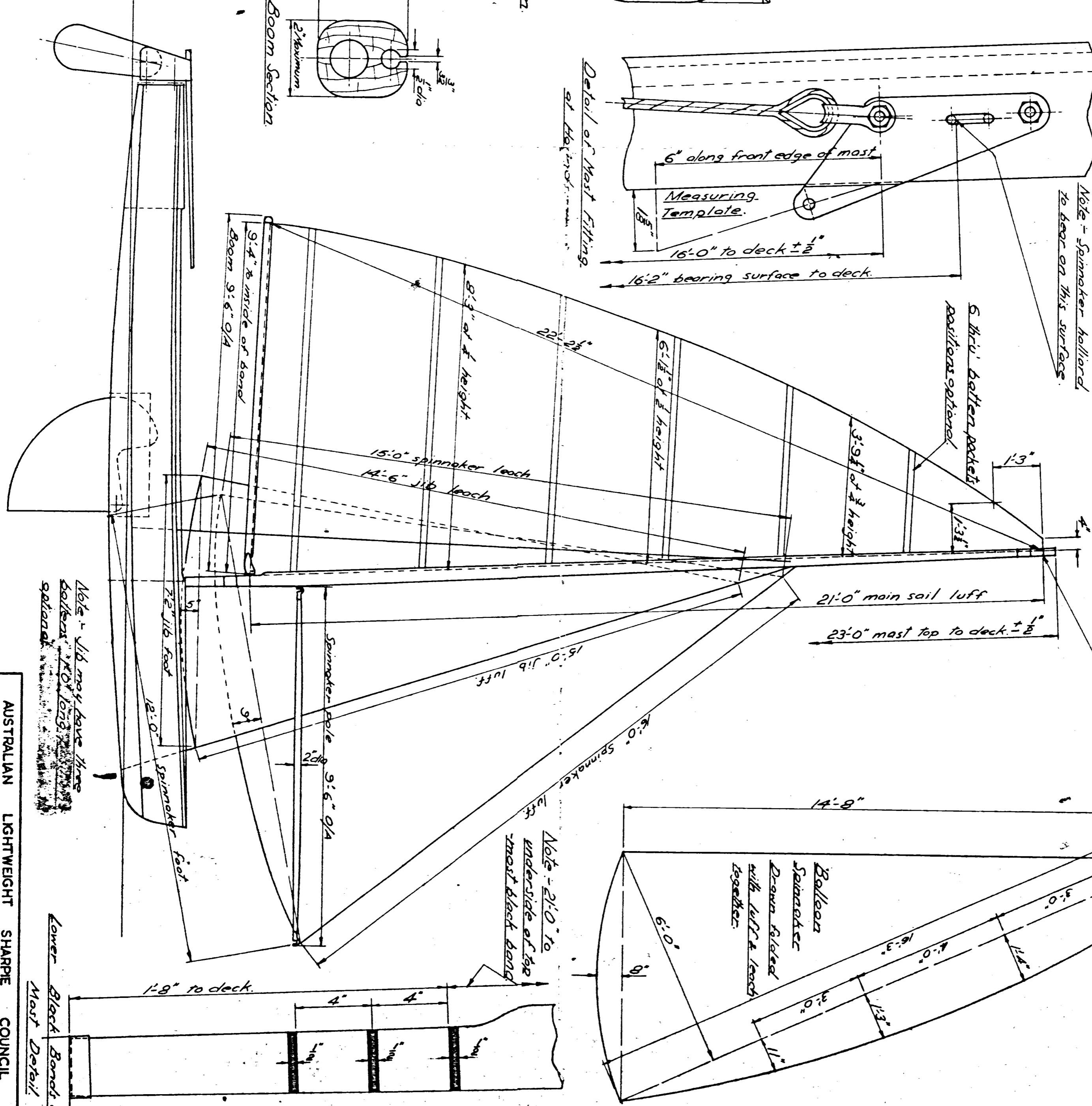
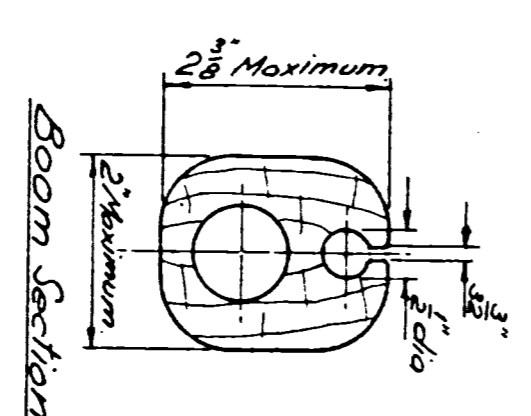

Note These dims to be read in conjunction with Sharp's Manual

DRG 1

AUSTRALIAN LIGHTWEIGHT SHARPE COUNCIL	DRG No
LIGHTWEIGHT SHARPE SAIL PLAN, SPARS, RUDDER & CENTRE BOARD.	1